

FEATURES

- High performance, single-/dual-axis accelerometer on a single IC chip
- 5 mm × 5 mm × 2 mm LCC package
- 1 mg resolution at 60 Hz
- Low power: 700 μA at $V_S = 5\text{ V}$ (typical)
- High zero g bias stability
- High sensitivity accuracy
- -40°C to $+125^\circ\text{C}$ temperature range
- X and Y axes aligned to within 0.1° (typical)
- Bandwidth adjustment with a single capacitor
- Single-supply operation
- 3500 g shock survival
- RoHS compliant
- Compatible with Sn/Pb- and Pb-free solder processes
- Qualified for automotive applications

APPLICATIONS

- Vehicle dynamic controls
- Electronic chassis controls
- Platform stabilization/leveling
- Navigation
- Alarms and motion detectors
- High accuracy, 2-axis tilt sensing
- Vibration monitoring and compensation
- Abuse event detection

GENERAL DESCRIPTION

The [ADXL103/ADXL203](#) are high precision, low power, complete single- and dual-axis accelerometers with signal conditioned voltage outputs, all on a single, monolithic IC. The [ADXL103/ADXL203](#) measure acceleration with a full-scale range of $\pm 1.7\text{ g}$, $\pm 5\text{ g}$, or $\pm 18\text{ g}$. The [ADXL103/ADXL203](#) can measure both dynamic acceleration (for example, vibration) and static acceleration (for example, gravity).

The typical noise floor is $110\ \mu\text{g}/\sqrt{\text{Hz}}$, allowing signals below 1 mg (0.06° of inclination) to be resolved in tilt sensing applications using narrow bandwidths ($< 60\text{ Hz}$).

The user selects the bandwidth of the accelerometer using Capacitor C_X and Capacitor C_Y at the X_{OUT} and Y_{OUT} pins. Bandwidths of 0.5 Hz to 2.5 kHz can be selected to suit the application.

The [ADXL103](#) and [ADXL203](#) are available in a 5 mm × 5 mm × 2 mm, 8-terminal ceramic LCC package.

FUNCTIONAL BLOCK DIAGRAMS

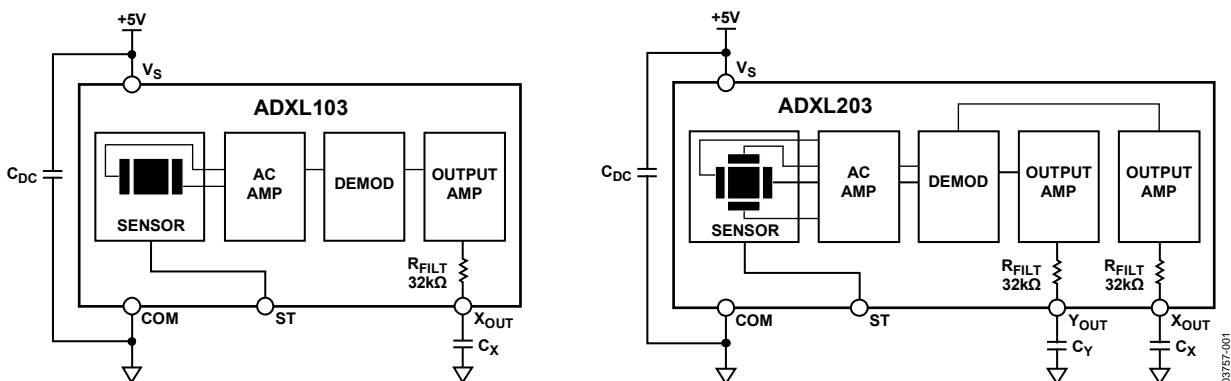

Figure 1.

Rev. D

Information furnished by Analog Devices is believed to be accurate and reliable. However, no responsibility is assumed by Analog Devices for its use, nor for any infringements of patents or other rights of third parties that may result from its use. Specifications subject to change without notice. No license is granted by implication or otherwise under any patent or patent rights of Analog Devices. Trademarks and registered trademarks are the property of their respective owners.

TABLE OF CONTENTS

| | | | |
|--|----|--|----|
| Features | 1 | Performance | 13 |
| Applications | 1 | Applications Information | 14 |
| General Description | 1 | Power Supply Decoupling | 14 |
| Functional Block Diagrams | 1 | Setting the Bandwidth Using C_X and C_Y | 14 |
| Specifications | 3 | Self Test | 14 |
| Absolute Maximum Ratings | 4 | Design Trade-Offs for Selecting Filter Characteristics: The Noise/Bandwidth Trade-Off | 14 |
| ESD Caution | 4 | Using the ADXL103/ADXL203 with Operating Voltages Other than 5 V | 15 |
| Pin Configurations and Function Descriptions | 5 | Using the ADXL203 as a Dual-Axis Tilt Sensor | 15 |
| Typical Performance Characteristics | 6 | Outline Dimensions | 16 |
| ADXL103 and ADXL203 | 6 | Ordering Guide | 16 |
| AD22293 | 9 | Automotive Products | 16 |
| AD22035 and AD22037 | 10 | | |
| All Models | 12 | | |
| Theory of Operation | 13 | | |

REVISION HISTORY

9/11—Rev. C to Rev. D

| | |
|---|------------|
| Added AD22293, AD22035, and AD22037 | Throughout |
| Changes to Application Section and General Description Section | 1 |
| Changes to Table 1 | 3 |
| Deleted Figure 13 and Figure 14: Renumbered Sequentially | 7 |
| Deleted Figure 17 and Figure 22 | 8 |
| Added Figure 19 to Figure 24; Renumbered Sequentially | 9 |
| Added Figure 25 to Figure 34 | 10 |
| Added All Models Section, Figure 35 to Figure 38 | 12 |
| Changes to Figure 39 | 13 |
| Changes to Ordering Guide | 16 |
| Changes to Automotive Products Section | 16 |

5/10—Rev. B to Rev. C

| | |
|---|----|
| Changes to Figure 24 Caption | 12 |
| Added Automotive Products Section | 12 |

4/10—Rev. A to Rev. B

| | |
|-----------------------------------|----|
| Changes to Features Section | 1 |
| Updated Outline Dimensions | 12 |
| Changes to Ordering Guide | 12 |

2/06—Rev. 0 to Rev. A

| | |
|--|---|
| Changes to Features | 1 |
| Changes to Table 1 | 3 |
| Changes to Figure 2 | 4 |
| Changes to Figure 3 and Figure 4 | 5 |
| Changes to the Performance Section | 9 |

4/04—Revision 0: Initial Version

SPECIFICATIONS

$T_A = -40^{\circ}\text{C}$ to $+125^{\circ}\text{C}$, $V_S = 5\text{ V}$, $C_X = C_Y = 0.1\ \mu\text{F}$, acceleration = 0 g , unless otherwise noted. All minimum and maximum specifications are guaranteed. All typical specifications are not guaranteed.

Table 1.

| Parameter | Test Conditions | ADXL103/ADXL203 | | | AD22293 | | | AD22035/AD22037 | | | Unit |
|--|---|-----------------|------|-------|---------|------|-------|-----------------|------|-------|------------------------------------|
| | | Min | Typ | Max | Min | Typ | Max | Min | Typ | Max | |
| SENSOR | Each axis | | | | | | | | | | |
| Measurement Range ¹ | | ±1.7 | | | ±5 | ±6 | | ±18 | | | g |
| Nonlinearity | % of full scale | | ±0.2 | ±1.25 | | ±0.2 | ±1.25 | | ±0.2 | ±1.25 | % |
| Package Alignment Error | | | ±1 | | | ±1 | | | ±1 | | Degrees |
| Alignment Error (ADXL203) | X to Y sensor | | ±0.1 | | | ±0.1 | | | ±0.1 | | Degrees |
| Cross-Axis Sensitivity | | | ±1.5 | ±3 | | ±1.5 | ±3 | | ±1.5 | ±3 | % |
| SENSITIVITY (RATIOMETRIC) ² | Each axis | | | | | | | | | | |
| Sensitivity at X_{OUT} , Y_{OUT} | $V_S = 5\text{ V}$ | 960 | 1000 | 1040 | 293 | 312 | 331 | 94 | 100 | 106 | mV/g |
| Sensitivity Change Due to Temperature ³ | $V_S = 5\text{ V}$ | | ±0.3 | | | ±0.3 | | | ±0.3 | | % |
| ZERO g BIAS LEVEL (RATIOMETRIC) | Each axis | | | | | | | | | | |
| 0 g Voltage at X_{OUT} , Y_{OUT} | $V_S = 5\text{ V}$ | 2.4 | 2.5 | 2.6 | 2.4 | 2.5 | 2.6 | 2.4 | 2.5 | 2.6 | V |
| Initial 0 g Output Deviation From Ideal | $V_S = 5\text{ V}$, 25°C | | ±25 | | | ±50 | | | ±125 | | mg |
| 0 g Offset vs. Temperature | | | ±0.1 | ±0.8 | | ±0.3 | ±1.8 | | ±1 | | mg/°C |
| NOISE | | | | | | | | | | | |
| Output Noise | <4 kHz, $V_S = 5\text{ V}$ | | 1 | 3 | | 1 | 3 | | | 2 | mV rms |
| Noise Density | | | 110 | | | 200 | | | 130 | | $\mu\text{g}/\sqrt{\text{Hz}}$ rms |
| FREQUENCY RESPONSE ⁴ | | | | | | | | | | | |
| C_X , C_Y Range ⁵ | | 0.002 | | 10 | 0.002 | | 10 | 0.002 | | 10 | μF |
| R_{FLT} Tolerance | | 24 | 32 | 40 | 24 | 32 | 40 | 24 | 32 | 40 | k Ω |
| Sensor Resonant Frequency | | | 5.5 | | | 5.5 | | | 5.5 | | kHz |
| SELF TEST ⁶ | | | | | | | | | | | |
| Logic Input Low | | | | 1 | | | 1 | | | 1 | V |
| Logic Input High | | 4 | | | 4 | | | 4 | | | V |
| ST Input Resistance to GND | | 30 | 50 | | 30 | 50 | | 30 | 50 | | k Ω |
| Output Change at X_{OUT} , Y_{OUT} | ST 0 to ST 1 | 450 | 750 | 1100 | 125 | 250 | 375 | 60 | 80 | 100 | mV |
| OUTPUT AMPLIFIER | | | | | | | | | | | |
| Output Swing Low | No load | 0.05 | 0.2 | | 0.05 | 0.2 | | 0.05 | 0.2 | | V |
| Output Swing High | No load | | 4.5 | 4.8 | | 4.5 | 4.8 | | 4.5 | 4.8 | V |
| POWER SUPPLY (V_{DD}) | | | | | | | | | | | |
| Operating Voltage Range | | 3 | | 6 | 3 | | 6 | 3 | | 6 | V |
| Quiescent Supply Current | | | 0.7 | 1.1 | | 0.7 | 1.1 | | 0.7 | 1.1 | mA |
| Turn-On Time ⁷ | | | 20 | | | 20 | | | 20 | | ms |

¹ Guaranteed by measurement of initial offset and sensitivity.

² Sensitivity is essentially ratiometric to V_S . For $V_S = 4.75\text{ V}$ to 5.25 V , sensitivity is 186 mV/V/g to 215 mV/V/g .

³ Defined as the output change from ambient-to-maximum temperature or ambient-to-minimum temperature.

⁴ Actual frequency response controlled by user-supplied external capacitor (C_X , C_Y).

⁵ Bandwidth = $1/(2 \times \pi \times 32\text{ k}\Omega \times C)$. For C_X , $C_Y = 0.002\ \mu\text{F}$, bandwidth = 2500 Hz . For C_X , $C_Y = 10\ \mu\text{F}$, bandwidth = 0.5 Hz . Minimum/maximum values are not tested.

⁶ Self-test response changes cubically with V_S .

⁷ Larger values of C_X , C_Y increase turn-on time. Turn-on time is approximately $160 \times C_X$ or $C_Y + 4\text{ ms}$, where C_X , C_Y are in μF .

ABSOLUTE MAXIMUM RATINGS

Table 2.

| Parameter | Rating |
|---|---|
| Acceleration (Any Axis, Unpowered) | 3500 g |
| Acceleration (Any Axis, Powered) | 3500 g |
| Drop Test (Concrete Surface) | 1.2 m |
| V _s | -0.3 V to +7.0 V |
| All Other Pins | (COM - 0.3 V) to (V _s + 0.3 V) |
| Output Short-Circuit Duration (Any Pin to Common) | Indefinite |
| Temperature Range (Powered) | -55°C to +125°C |
| Temperature Range (Storage) | -65°C to +150°C |

Stresses above those listed under Absolute Maximum Ratings may cause permanent damage to the device. This is a stress rating only; functional operation of the device at these or any other conditions above those indicated in the operational section of this specification is not implied. Exposure to absolute maximum rating conditions for extended periods may affect device reliability.

Table 3. Package Characteristics

| Package Type | θ _{JA} | θ _{JC} | Device Weight |
|------------------------|-----------------|-----------------|---------------|
| 8-Terminal Ceramic LCC | 120°C/W | 20°C/W | <1.0 gram |

ESD CAUTION



ESD (electrostatic discharge) sensitive device. Charged devices and circuit boards can discharge without detection. Although this product features patented or proprietary protection circuitry, damage may occur on devices subjected to high energy ESD. Therefore, proper ESD precautions should be taken to avoid performance degradation or loss of functionality.

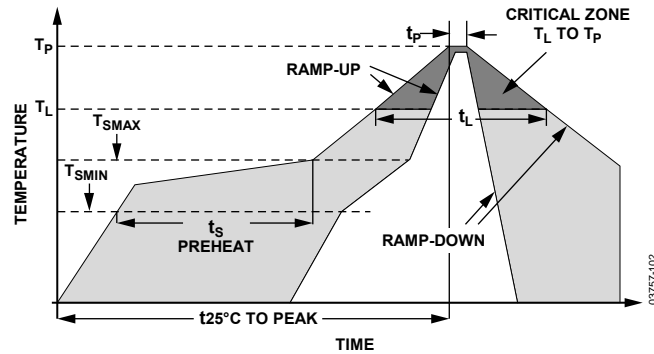
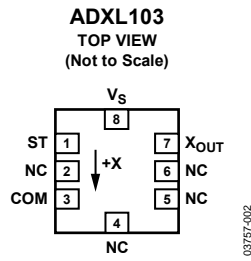

Figure 2. Recommended Soldering Profile

Table 4. Solder Profile Parameters

| Profile Feature | Test Condition | |
|--|---------------------------|---------------------------|
| | Sn63/Pb37 | Pb-Free |
| Average Ramp Rate (T _L to T _P) | 3°C/second maximum | 3°C/second maximum |
| Preheat | | |
| Minimum Temperature (T _{SMIN}) | 100°C | 150°C |
| Maximum Temperature (T _{SMAX}) | 150°C | 200°C |
| Time (T _{SMIN} to T _{SMAX}) (t _s) | 60 seconds to 120 seconds | 60 seconds to 150 seconds |
| T _{SMAX} to T _L | | |
| Ramp-Up Rate | 3°C/second | 3°C/second |
| Time Maintained above Liquidous (T _L) | | |
| Liquidous Temperature (T _L) | 183°C | 217°C |
| Time (t _L) | 60 seconds to 150 seconds | 60 seconds to 150 seconds |
| Peak Temperature (T _P) | 240°C + 0°C/-5°C | 260°C + 0°C/-5°C |
| Time Within 5°C of Actual Peak Temperature (t _p) | 10 seconds to 30 seconds | 20 seconds to 40 seconds |
| Ramp-Down Rate | 6°C/second maximum | 6°C/second maximum |
| Time 25°C to Peak Temperature | 6 minutes maximum | 8 minutes maximum |

PIN CONFIGURATIONS AND FUNCTION DESCRIPTIONS



NOTES
1. NC = NO CONNECT. DO NOT CONNECT TO THIS PIN.

Figure 3. ADXL103 Pin Configuration

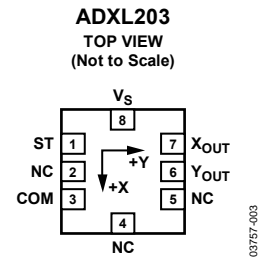

NOTES
1. NC = NO CONNECT. DO NOT CONNECT TO THIS PIN.

Figure 4. ADXL203 Pin Configuration

Table 5. ADXL103 Pin Function Descriptions

| Pin No. | Mnemonic | Description |
|---------|------------------|------------------|
| 1 | ST | Self Test |
| 2 | NC | Do Not Connect |
| 3 | COM | Common |
| 4 | NC | Do Not Connect |
| 5 | NC | Do Not Connect |
| 6 | NC | Do Not Connect |
| 7 | X _{OUT} | X Channel Output |
| 8 | V _S | 3 V to 6 V |

Table 6. ADXL203 Pin Function Descriptions

| Pin No. | Mnemonic | Description |
|---------|------------------|------------------|
| 1 | ST | Self Test |
| 2 | NC | Do Not Connect |
| 3 | COM | Common |
| 4 | NC | Do Not Connect |
| 5 | NC | Do Not Connect |
| 6 | Y _{OUT} | Y Channel Output |
| 7 | X _{OUT} | X Channel Output |
| 8 | V _S | 3 V to 6 V |

TYPICAL PERFORMANCE CHARACTERISTICS

ADXL103 AND ADXL203

$V_s = 5\text{ V}$ for all graphs, unless otherwise noted.

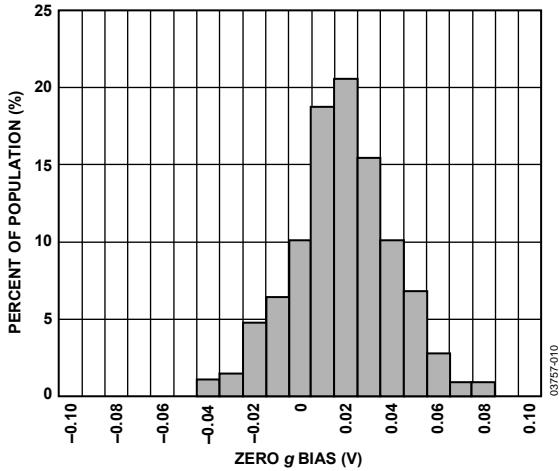

Figure 5. X-Axis Zero g Bias Deviation from Ideal at 25°C

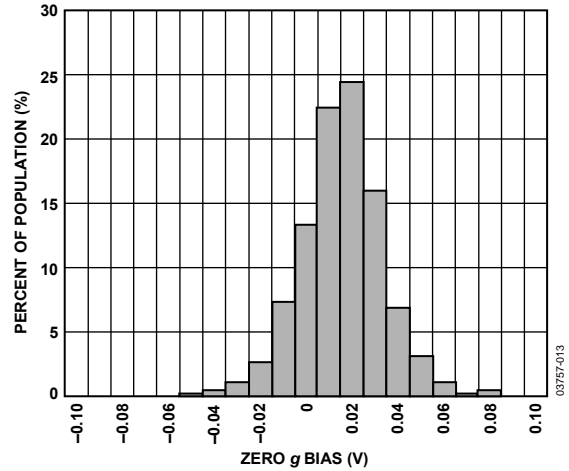

Figure 8. Y-Axis Zero g Bias Deviation from Ideal at 25°C

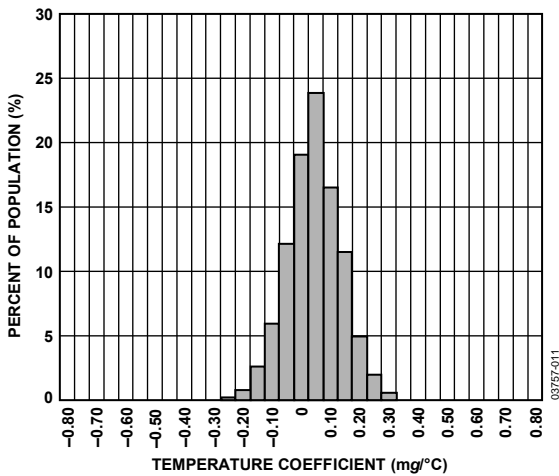

Figure 6. X-Axis Zero g Bias Temperature Coefficient

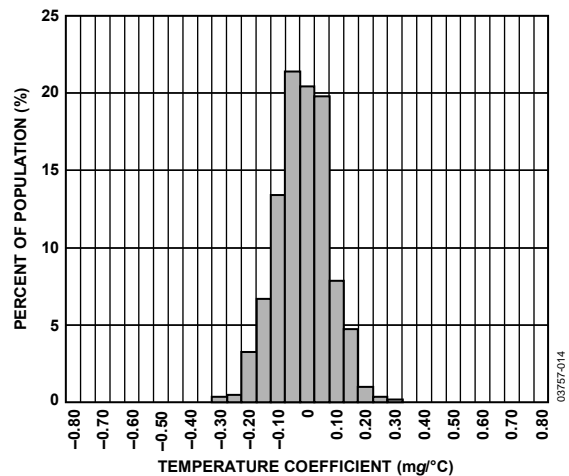

Figure 9. Y-Axis Zero g Bias Temperature Coefficient

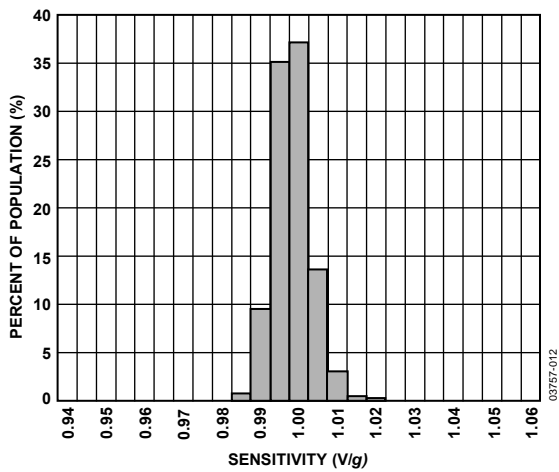

Figure 7. X-Axis Sensitivity at 25°C

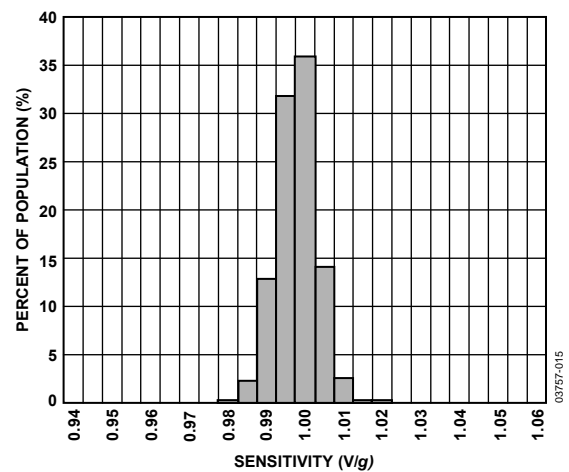

Figure 10. Y-Axis Sensitivity at 25°C

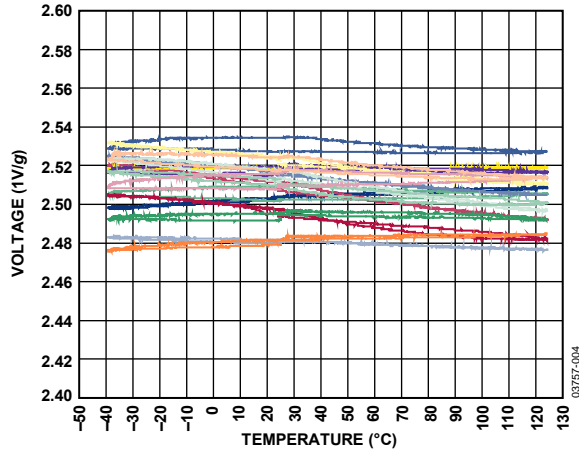

Figure 11. Zero g Bias vs. Temperature; Parts Soldered to PCB

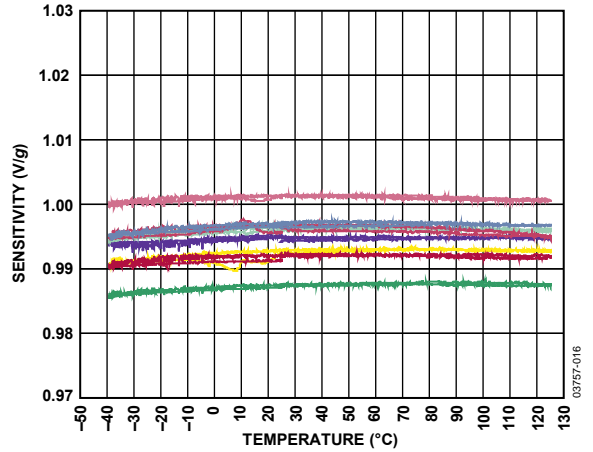

Figure 13. Sensitivity vs. Temperature; Parts Soldered to PCB

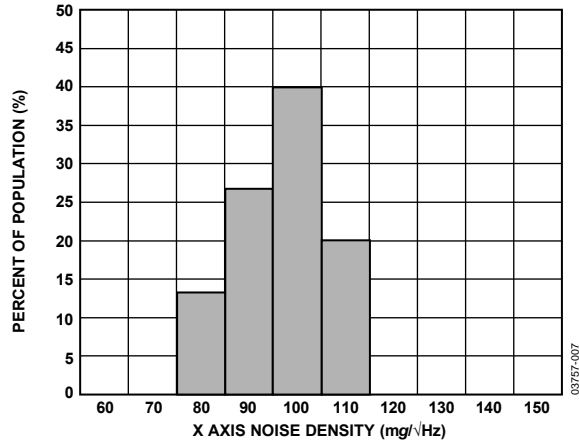

Figure 12. X-Axis Noise Density at 25°C

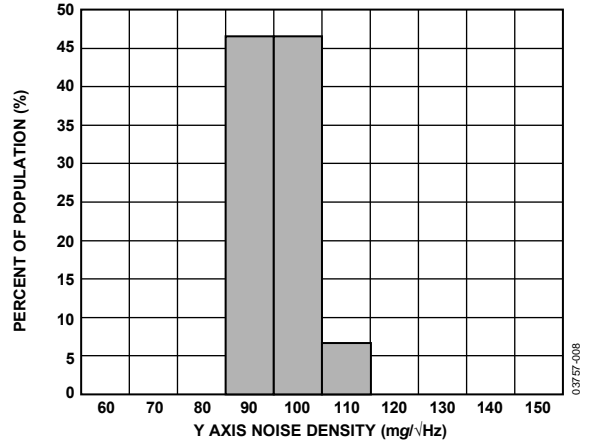

Figure 14. Y-Axis Noise Density at 25°C

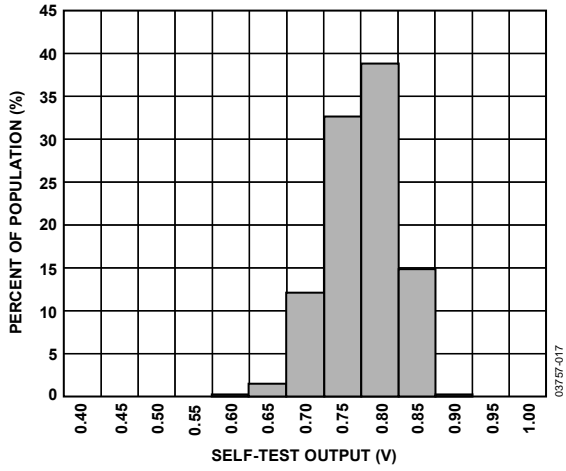

Figure 15. X-Axis Self-Test Response at 25°C

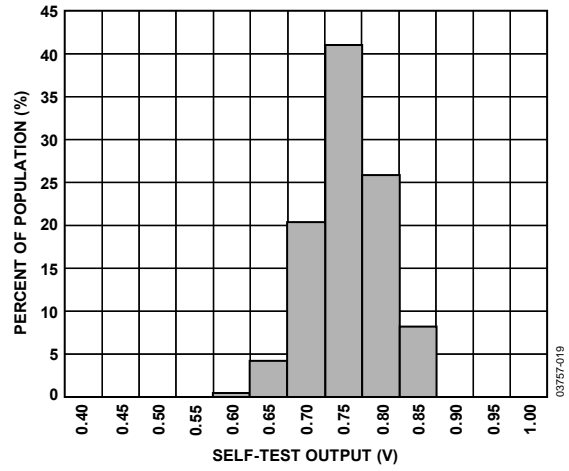

Figure 17. Y-Axis Self-Test Response at 25°C

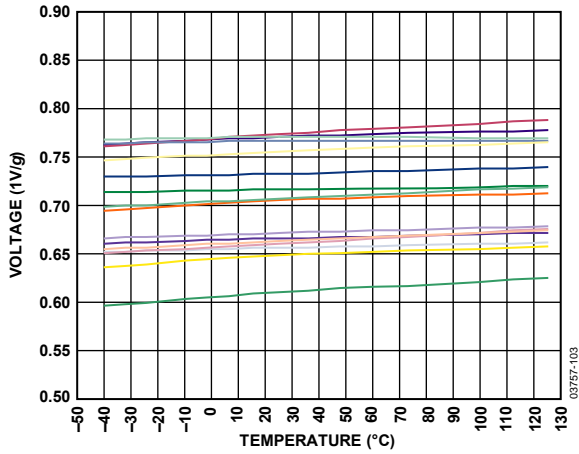

Figure 16. Self-Test Response vs. Temperature

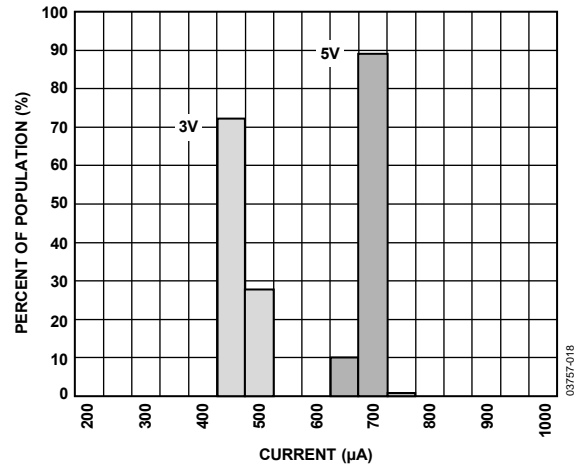

Figure 18. Supply Current at 25°C

AD22293

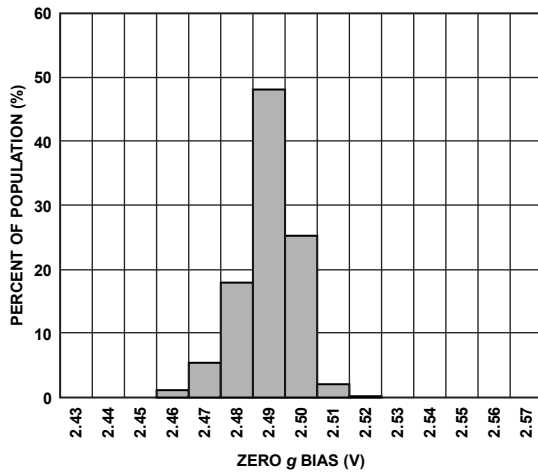

Figure 19. X-Axis Zero g Bias at 25°C

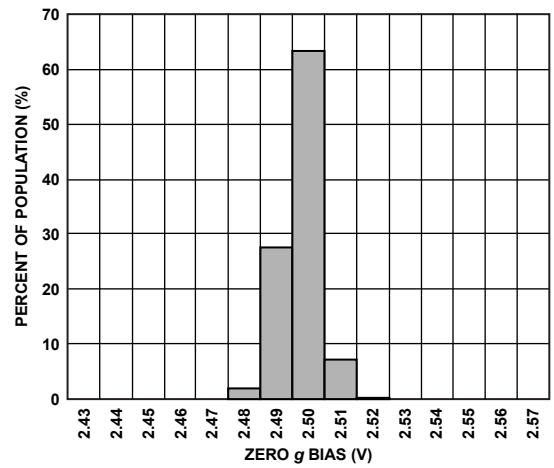

Figure 22. Y-Axis Zero g Bias at 25°C

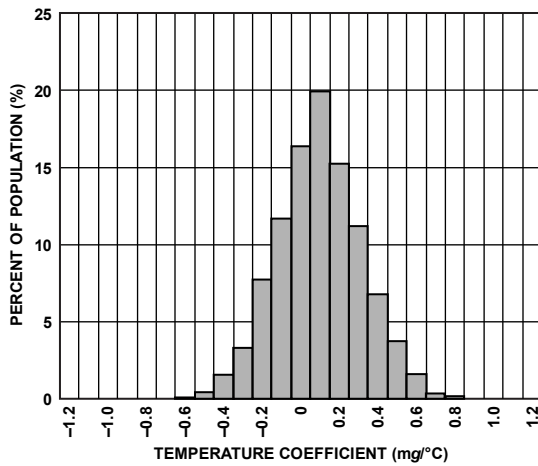

Figure 20. X-Axis Zero g Bias Temperature Coefficient

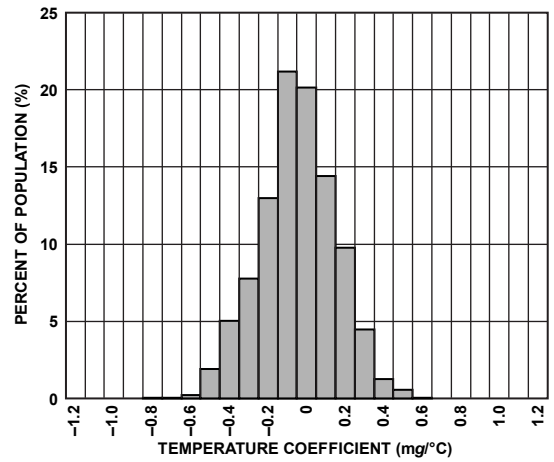

Figure 23. Y-Axis Zero g Bias Temperature Coefficient

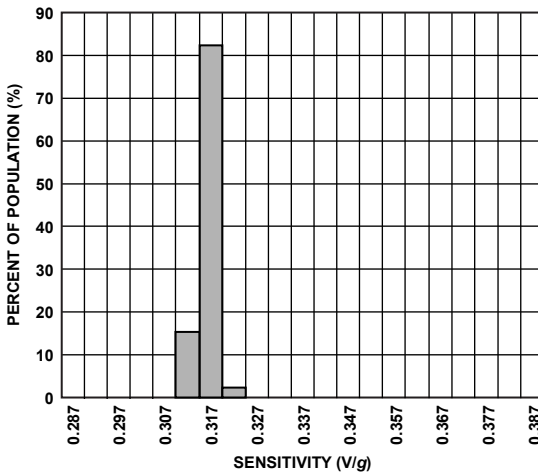

Figure 21. X-Axis Sensitivity at 25°C

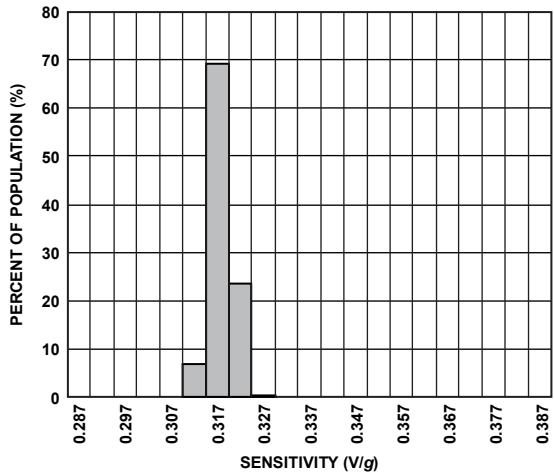

Figure 24. Y-Axis Sensitivity at 25°C

AD22035 AND AD22037

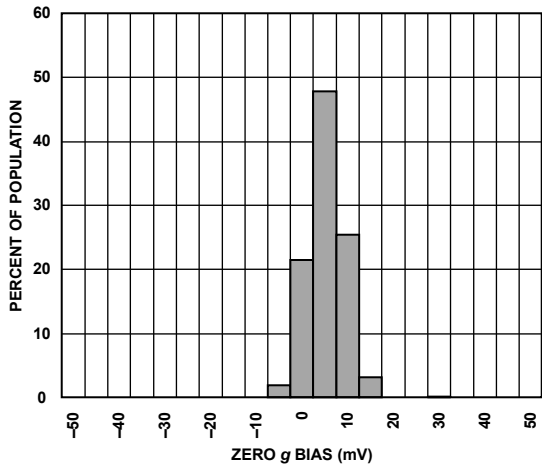

Figure 25. X-Axis Zero g Bias Deviation from Ideal at 25°C

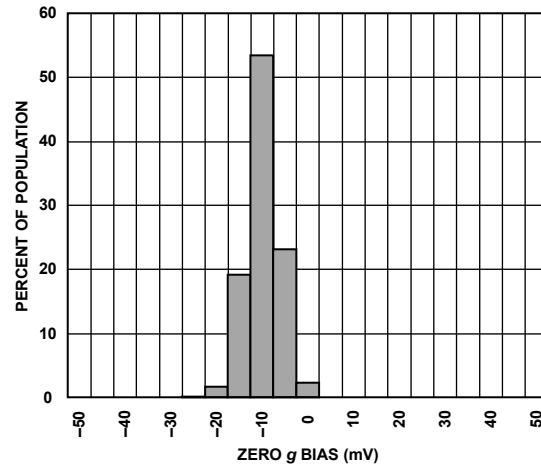

Figure 28. Y-Axis Zero g Bias Deviation from Ideal at 25°C

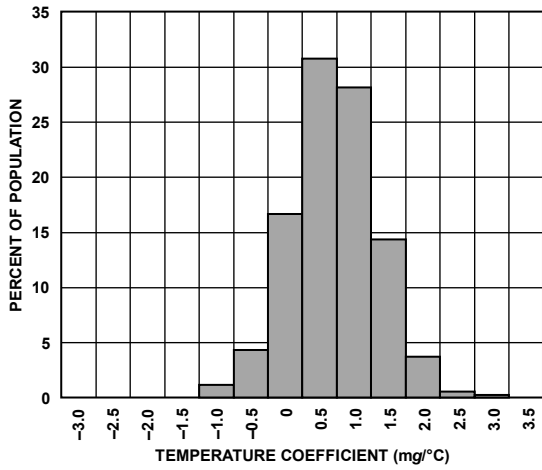

Figure 26. X-Axis Zero g Bias Temperature Coefficient

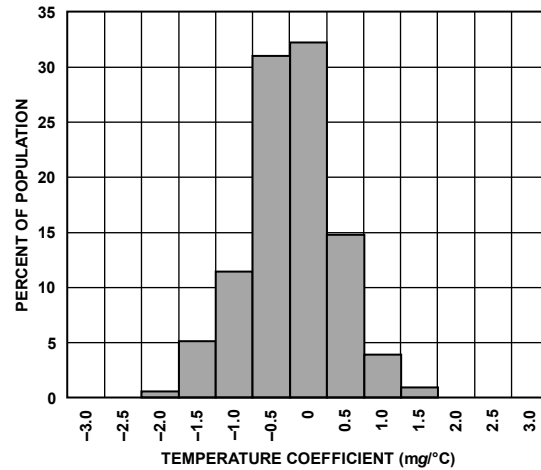

Figure 29. Y-Axis Zero g Bias Temperature Coefficient

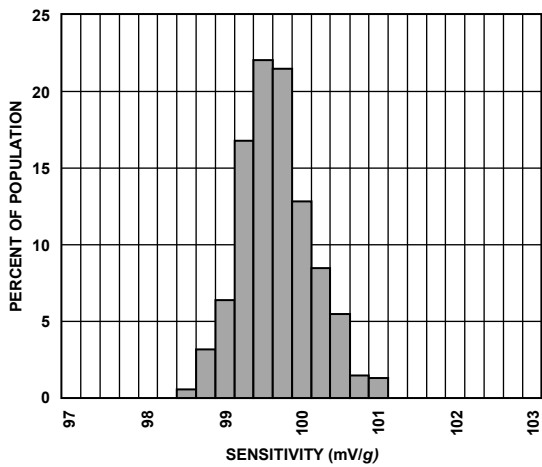

Figure 27. X-Axis Sensitivity at 25°C

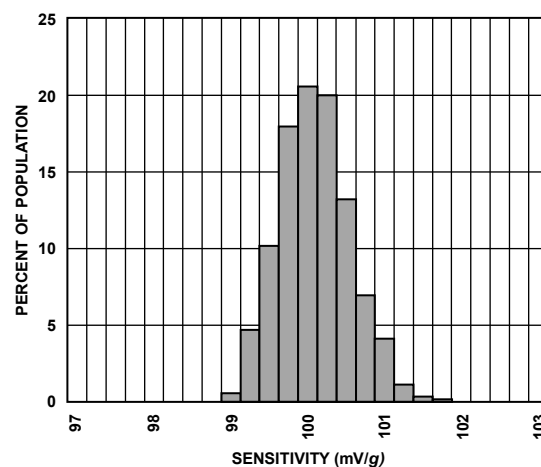

Figure 30. Y-Axis Sensitivity at 25°C

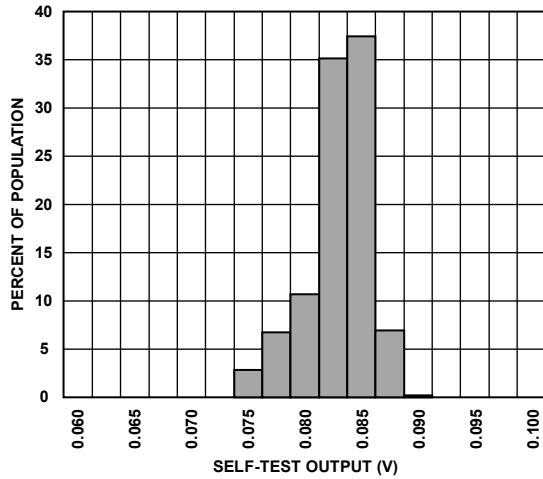

Figure 31. X-Axis Self Test Response at 25°C

03757-111

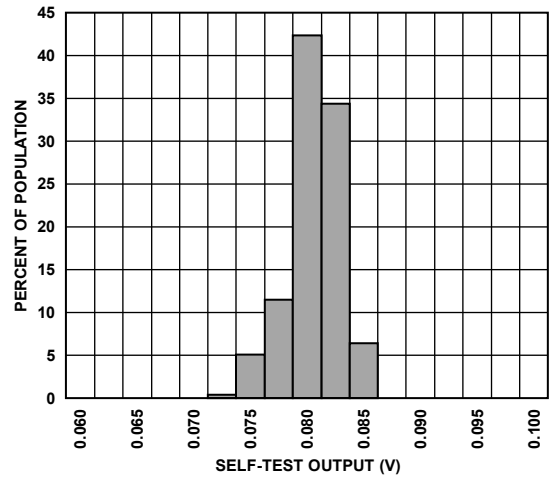

Figure 33. Y-Axis Self Test Response at 25°C

03757-114

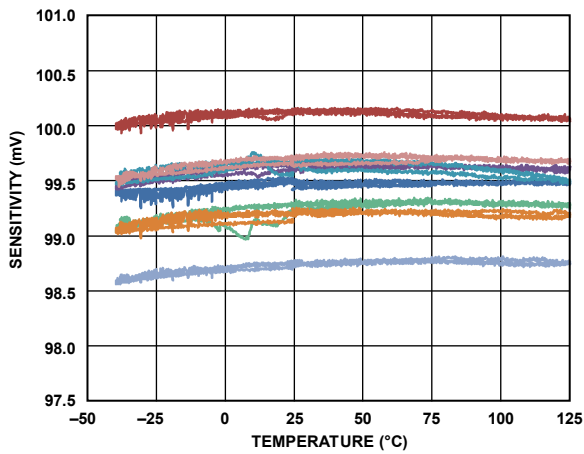

Figure 32. Sensitivity vs. Temperature; Parts Soldered to PCB

03757-112

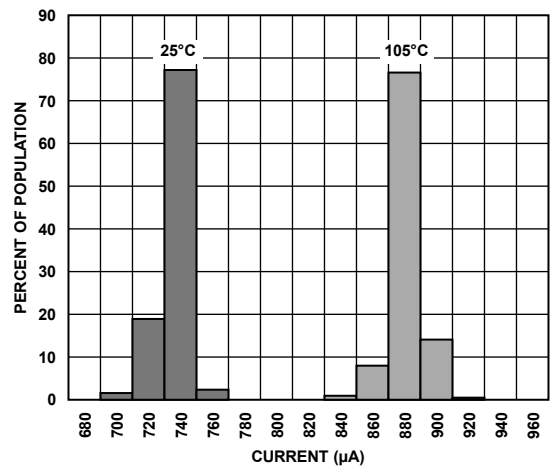

Figure 34. Supply Current vs. Temperature

03757-113

ALL MODELS

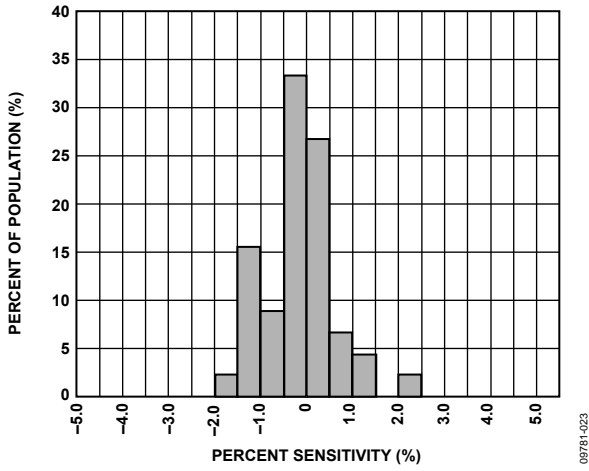

Figure 35. Z vs. X Cross-Axis Sensitivity

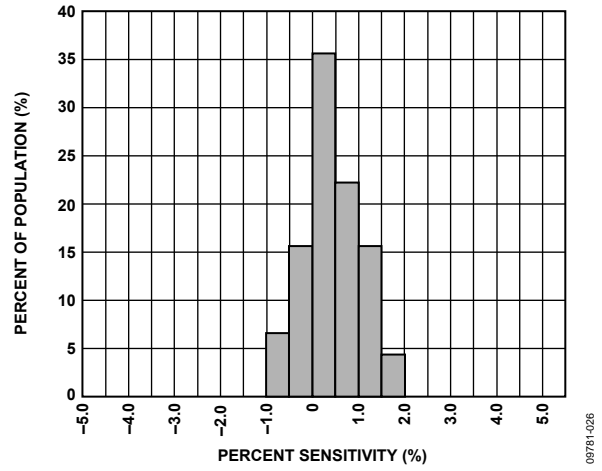

Figure 37. Z vs. Y Cross-Axis Sensitivity

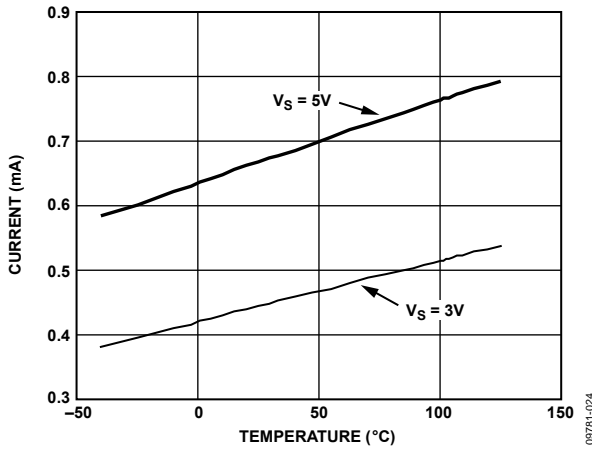

Figure 36. Supply Current vs. Temperature

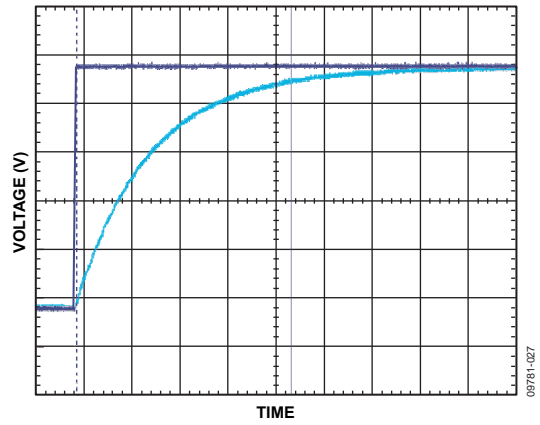

Figure 38. Turn-On Time; $C_x, C_Y = 0.1 \mu F$, Time Scale = 2 ms/DIV

THEORY OF OPERATION

The ADXL103/ADXL203 are complete acceleration measurement systems on a single, monolithic IC. The ADXL103 is a single-axis accelerometer, and the ADXL203 is a dual-axis accelerometer. Both parts contain a polysilicon surface-micro-machined sensor and signal conditioning circuitry to implement an open-loop acceleration measurement architecture. The output signals are analog voltages that are proportional to acceleration. The ADXL103/ADXL203 are capable of measuring both positive and negative accelerations from $\pm 1.7 g$ to at least $\pm 18 g$. The accelerometer can measure static acceleration forces, such as gravity, allowing it to be used as a tilt sensor.

The sensor is a surface-micromachined polysilicon structure built on top of the silicon wafer. Polysilicon springs suspend the structure over the surface of the wafer and provide a resistance against acceleration forces. Deflection of the structure is measured using a differential capacitor that consists of independent fixed plates and plates attached to the moving mass. The fixed plates are driven by 180° out-of-phase square waves. Acceleration deflects the beam and unbalances the differential capacitor, resulting in an output square wave whose amplitude is proportional to acceleration. Phase-sensitive demodulation techniques are then used to rectify the signal and determine the direction of the acceleration.

The output of the demodulator is amplified and brought off-chip through a $32 k\Omega$ resistor. At this point, the user can set the signal bandwidth of the device by adding a capacitor. This filtering improves measurement resolution and helps prevent aliasing.

PERFORMANCE

Rather than using additional temperature compensation circuitry, innovative design techniques have been used to ensure that high performance is built in. As a result, there is essentially no quantization error or nonmonotonic behavior, and temperature hysteresis is very low (typically less than $10 mg$ over the $-40^\circ C$ to $+125^\circ C$ temperature range).

Figure 11 shows the $0 g$ output performance of eight parts (x and y axes) over a $-40^\circ C$ to $+125^\circ C$ temperature range.

Figure 13 demonstrates the typical sensitivity shift over temperature for $V_s = 5 V$. Sensitivity stability is optimized for $V_s = 5 V$ but is still very good over the specified range; it is typically better than $\pm 1\%$ over temperature at $V_s = 3 V$.

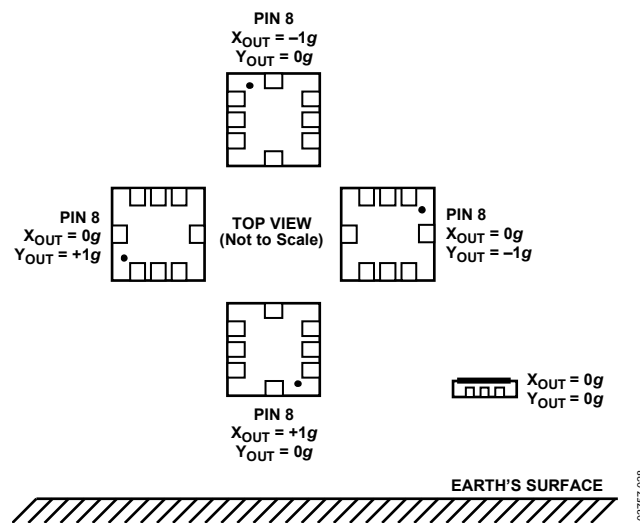

Figure 39. Output Response vs. Orientation

APPLICATIONS INFORMATION

POWER SUPPLY DECOUPLING

For most applications, a single 0.1 μF capacitor, C_{DC} , adequately decouples the accelerometer from noise on the power supply. However, in some cases, particularly where noise is present at the 140 kHz internal clock frequency (or any harmonic thereof), noise on the supply can cause interference on the ADXL103/ADXL203 output. If additional decoupling is needed, a 100 Ω (or smaller) resistor or ferrite beads can be inserted in the supply line of the ADXL103/ADXL203. Additionally, a larger bulk bypass capacitor (in the 1 μF to 22 μF range) can be added in parallel to C_{DC} .

SETTING THE BANDWIDTH USING C_X AND C_Y

The ADXL103/ADXL203 has provisions for band limiting the X_{OUT} and Y_{OUT} pins. Capacitors must be added at these pins to implement low-pass filtering for antialiasing and noise reduction. The equation for the 3 dB bandwidth is

$$f_{-3\text{ dB}} = 1/(2\pi(32\text{ k}\Omega) \times C_{(X, Y)})$$

or more simply,

$$f_{-3\text{ dB}} = 5\ \mu\text{F}/C_{(X, Y)}$$

The tolerance of the internal resistor (R_{FILT}) can vary typically as much as $\pm 25\%$ of its nominal value (32 k Ω); thus, the bandwidth varies accordingly. A minimum capacitance of 2000 pF for C_X and C_Y is required in all cases.

Table 7. Filter Capacitor Selection, C_X and C_Y

| Bandwidth (Hz) | Capacitor (μF) |
|----------------|-----------------------------|
| 1 | 4.7 |
| 10 | 0.47 |
| 50 | 0.10 |
| 100 | 0.05 |
| 200 | 0.027 |
| 500 | 0.01 |

SELF TEST

The ST pin controls the self test feature. When this pin is set to V_S , an electrostatic force is exerted on the beam of the accelerometer. The resulting movement of the beam allows the user to test if the accelerometer is functional. The typical change in output is 750 mg (corresponding to 750 mV). This pin can be left open-circuit or connected to common in normal use.

Never expose the ST pin to voltages greater than $V_S + 0.3\text{ V}$. If the system design is such that this condition cannot be guaranteed (that is, multiple supply voltages are present), a low V_F clamping diode between ST and V_S is recommended.

DESIGN TRADE-OFFS FOR SELECTING FILTER CHARACTERISTICS: THE NOISE/BANDWIDTH TRADE-OFF

The accelerometer bandwidth selected ultimately determines the measurement resolution (smallest detectable acceleration). Filtering can be used to lower the noise floor, improving the resolution of the accelerometer. Resolution is dependent on the analog filter bandwidth at X_{OUT} and Y_{OUT} .

The output of the ADXL103/ADXL203 has a typical bandwidth of 2.5 kHz. The user must filter the signal at this point to limit aliasing errors. The analog bandwidth must be no more than half the analog-to-digital sampling frequency to minimize aliasing. The analog bandwidth can be further decreased to reduce noise and improve resolution.

The ADXL103/ADXL203 noise has the characteristics of white Gaussian noise, which contributes equally at all frequencies and is described in terms of $\mu\text{g}/\sqrt{\text{Hz}}$ (that is, the noise is proportional to the square root of the accelerometer bandwidth). Limit bandwidth to the lowest frequency needed by the application to maximize the resolution and dynamic range of the accelerometer.

With the single-pole roll-off characteristic, the typical noise of the ADXL103/ADXL203 is determined by

$$\text{rmsNoise} = (110\ \mu\text{g}/\sqrt{\text{Hz}}) \times (\sqrt{\text{BW} \times 1.6})$$

At 100 Hz, the noise is

$$\text{rmsNoise} = (110\ \mu\text{g}/\sqrt{\text{Hz}}) \times (\sqrt{100 \times 1.6}) = 1.4\ \text{mg}$$

Often, the peak value of the noise is desired. Peak-to-peak noise can only be estimated by statistical methods. Table 8 is useful for estimating the probabilities of exceeding various peak values, given the rms value.

Table 8. Estimation of Peak-to-Peak Noise

| Peak-to-Peak Value | % of Time That Noise Exceeds Nominal Peak-to-Peak Value |
|--------------------|---|
| 2 \times rms | 32 |
| 4 \times rms | 4.6 |
| 6 \times rms | 0.27 |
| 8 \times rms | 0.006 |

Peak-to-peak noise values give the best estimate of the uncertainty in a single measurement; peak-to-peak noise is estimated by 6 \times rms. Table 9 gives the typical noise output of the ADXL103/ADXL203 for various C_X and C_Y values.

Table 9. Filter Capacitor Selection (C_X , C_Y)

| Bandwidth (Hz) | C_X , C_Y (μF) | RMS Noise (mg) | Peak-to-Peak Noise Estimate (mg) |
|----------------|---------------------------------|----------------|----------------------------------|
| 10 | 0.47 | 0.4 | 2.6 |
| 50 | 0.1 | 1.0 | 6 |
| 100 | 0.047 | 1.4 | 8.4 |
| 500 | 0.01 | 3.1 | 18.7 |

USING THE ADXL103/ADXL203 WITH OPERATING VOLTAGES OTHER THAN 5 V

The ADXL103/ADXL203 is tested and specified at $V_s = 5$ V; however, it can be powered with V_s as low as 3 V or as high as 6 V. Some performance parameters change as the supply voltage is varied.

The ADXL103/ADXL203 output is ratiometric, so the output sensitivity (or scale factor) varies proportionally to the supply voltage. At $V_s = 3$ V, the output sensitivity is typically 560 mV/g.

The zero g bias output is also ratiometric, so the zero g output is nominally equal to $V_s/2$ at all supply voltages.

The output noise is not ratiometric but is absolute in volts; therefore, the noise density decreases as the supply voltage increases. This is because the scale factor (mV/g) increases while the noise voltage remains constant. At $V_s = 3$ V, the noise density is typically $190 \mu\text{g}/\sqrt{\text{Hz}}$.

Self test response in g is roughly proportional to the square of the supply voltage. However, when ratiometricity of sensitivity is factored in with supply voltage, self test response in volts is roughly proportional to the cube of the supply voltage. So at $V_s = 3$ V, the self test response is approximately equivalent to 150 mV or equivalent to 270 mg (typical).

The supply current decreases as the supply voltage decreases. Typical current consumption at $V_{DD} = 3$ V is 450 μA .

USING THE ADXL203 AS A DUAL-AXIS TILT SENSOR

One of the most popular applications of the ADXL203 is tilt measurement. An accelerometer uses the force of gravity as an input vector to determine the orientation of an object in space.

An accelerometer is most sensitive to tilt when its sensitive axis is perpendicular to the force of gravity, that is, parallel to the earth's surface. At this orientation, its sensitivity to changes in tilt is highest. When the accelerometer is oriented on axis to gravity, that is, near its +1 g or -1 g reading, the change in output acceleration per degree of tilt is negligible. When the accelerometer is perpendicular to gravity, its output changes nearly 17.5 mg per degree of tilt. At 45°, its output changes at only 12.2 mg per degree, and resolution declines.

Dual-Axis Tilt Sensor: Converting Acceleration to Tilt

When the accelerometer is oriented so both its x-axis and y-axis are parallel to the earth's surface, it can be used as a 2-axis tilt sensor with a roll axis and a pitch axis. Once the output signal from the accelerometer has been converted to an acceleration that varies between -1 g and +1 g , the output tilt in degrees is calculated as

$$PITCH = ASIN(A_x/1 g)$$

$$ROLL = ASIN(A_y/1 g)$$

Be sure to account for overranges. It is possible for the accelerometers to output a signal greater than $\pm 1 g$ due to vibration, shock, or other accelerations.

OUTLINE DIMENSIONS

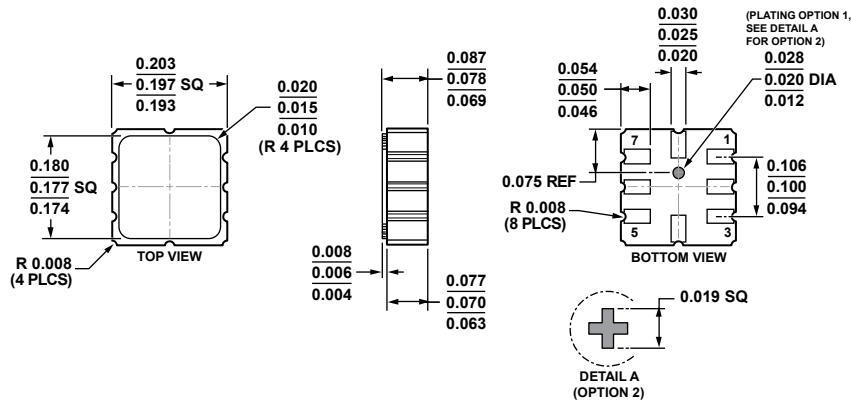

Figure 40. 8-Terminal Ceramic Leadless Chip Carrier [LCC] (E-8-1)
Dimensions shown in inches

ORDERING GUIDE

| Model ^{1, 2} | Axes | Device Generic | g-Range | Specified Voltage (V) | Temperature Range | Package Description | Package Option |
|-----------------------|------|----------------|---------|-----------------------|-------------------|------------------------|----------------|
| ADXL103CE | 1 | ADXL103 | ±1.7 | 5 | -40°C to +125°C | 8-Terminal Ceramic LCC | E-8-1 |
| ADXL103CE-REEL | 1 | ADXL103 | ±1.7 | 5 | -40°C to +125°C | 8-Terminal Ceramic LCC | E-8-1 |
| ADXL103WCEZB-REEL | 1 | ADXL103 | ±1.7 | 5 | -40°C to +125°C | 8-Terminal Ceramic LCC | E-8-1 |
| AD22035Z | 1 | ADXL103 | ±18 | 5 | -40°C to +125°C | 8-Terminal Ceramic LCC | E-8-1 |
| AD22035Z-RL | 1 | ADXL103 | ±18 | 5 | -40°C to +125°C | 8-Terminal Ceramic LCC | E-8-1 |
| AD22035Z-RL7 | 1 | ADXL103 | ±18 | 5 | -40°C to +125°C | 8-Terminal Ceramic LCC | E-8-1 |
| ADW22035Z | 1 | ADXL103 | ±18 | 5 | -40°C to +125°C | 8-Terminal Ceramic LCC | E-8-1 |
| ADW22035Z-RL | 1 | ADXL103 | ±18 | 5 | -40°C to +125°C | 8-Terminal Ceramic LCC | E-8-1 |
| ADW22035Z-RL7 | 1 | ADXL103 | ±18 | 5 | -40°C to +125°C | 8-Terminal Ceramic LCC | E-8-1 |
| ADXL203CE | 2 | ADXL203 | ±1.7 | 5 | -40°C to +125°C | 8-Terminal Ceramic LCC | E-8-1 |
| ADXL203CE-REEL | 2 | ADXL203 | ±1.7 | 5 | -40°C to +125°C | 8-Terminal Ceramic LCC | E-8-1 |
| ADXL203WCEZB-REEL | 2 | ADXL203 | ±1.7 | 5 | -40°C to +125°C | 8-Terminal Ceramic LCC | E-8-1 |
| ADXL203EB | | | | | | Evaluation Board | |
| AD22293ZA | 2 | ADXL203 | ±5 | 5 | -40°C to +125°C | 8-Terminal Ceramic LCC | E-8-1 |
| ADW22293ZA | 2 | ADXL203 | ±5 | 5 | -40°C to +125°C | 8-Terminal Ceramic LCC | E-8-1 |
| AD22037Z | 2 | ADXL203 | ±18 | 5 | -40°C to +125°C | 8-Terminal Ceramic LCC | E-8-1 |
| AD22037Z-RL | 2 | ADXL203 | ±18 | 5 | -40°C to +125°C | 8-Terminal Ceramic LCC | E-8-1 |
| AD22037Z-RL7 | 2 | ADXL203 | ±18 | 5 | -40°C to +125°C | 8-Terminal Ceramic LCC | E-8-1 |
| ADW22037Z | 2 | ADXL203 | ±18 | 5 | -40°C to +125°C | 8-Terminal Ceramic LCC | E-8-1 |
| ADW22037Z-RL | 2 | ADXL203 | ±18 | 5 | -40°C to +125°C | 8-Terminal Ceramic LCC | E-8-1 |
| ADW22037Z-RL7 | 2 | ADXL203 | ±18 | 5 | -40°C to +125°C | 8-Terminal Ceramic LCC | E-8-1 |

¹ Z = RoHS Compliant Part.
² W = Qualified for Automotive Applications.

AUTOMOTIVE PRODUCTS

The ADXL103W, ADW22035, ADXL203W, ADW22293, and ADW22037 models are available with controlled manufacturing to support the quality and reliability requirements of automotive applications. Note that these automotive models may have specifications that differ from the commercial models; therefore, designers should review the Specifications section of this data sheet carefully. Only the automotive grade products shown are available for use in automotive applications. Contact your local Analog Devices account representative for specific product ordering information and to obtain the specific Automotive Reliability reports for these models.